

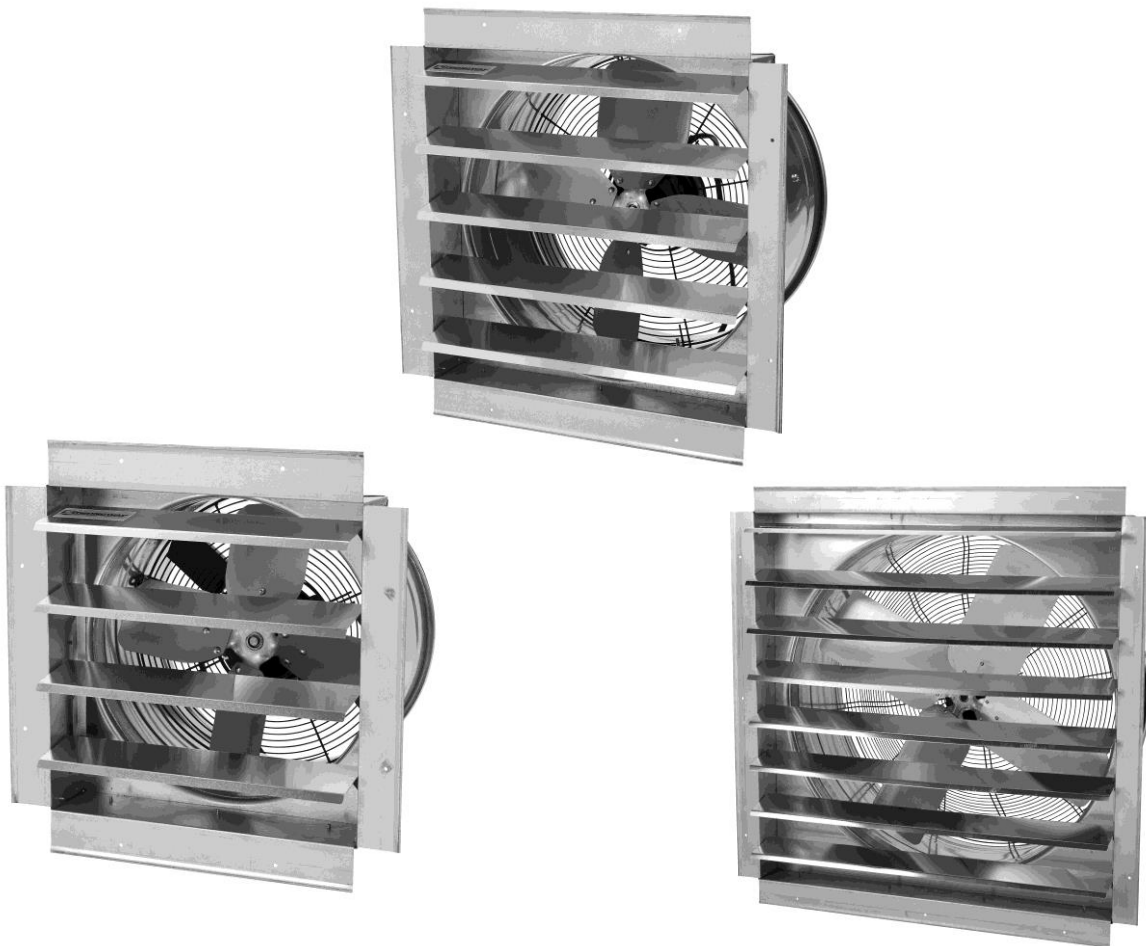

Exhaust Fan with Shutter

Owner's Manual



! WARNING: Read carefully and understand all ASSEMBLY AND OPERATION INSTRUCTIONS before operating. Failure to follow the safety rules and other basic safety precautions may result in serious personal injury.

Item # 52852, 52853, 52854

READ & SAVE THESE INSTRUCTIONS

Thank you very much for choosing a Strongway™ product!

For future reference, please complete the owner's record below:

Serial Number/Lot Date Code: _____

Purchase Date: _____

Save the receipt, warranty, and this manual. It is important that you read the entire manual to become familiar with this product before you begin using it.

This fan is designed for certain applications only. The distributor cannot be responsible for issues arising from modification or use of this product in an application for which it was not designed. We strongly recommend that this product not be modified and/or used for any application other than that for which it was designed.

For technical questions, please call **1-800-222-5381**.

Table of Contents

Intended Use.....4

Technical Specifications4

Important Safety Information4

Specific Operation Warnings.....6

Installation7

#52852, #52853, #52854 Wiring Diagram9

Before Each Use.....9

Operating Instructions.....9

Maintenance9

#52852 & #52853 Parts Diagram10

#52852 & #52853 Parts List10

#52854 Parts Diagram11

#52854 Parts List.....11

Replacement Parts.....12

Limited Warranty.....13

Intended Use

Strongway's Exhaust Fan with Shutter is designed for exhaust and circulation of indoor air to the outdoors.

Technical Specifications

Item#	Size	Voltage	Speeds	Watts / Amps	CFM / RPM
52852	14"	120	1	230 Watt / 1.9 Amp	1400/1380
52853	18"	120	1	330 Watt / 3 Amp	2800/1050
52854	30"	120	1	570 Watt / 5.2 Amp	5500/1050

Important Safety Information

WARNING

WARNING – TO REDUCE THE RISK OF FIRE, ELECTRIC SHOCK, OR INJURY TO PERSONS, OBSERVE THE FOLLOWING:

- a) Use this unit only in the manner intended by the manufacturer. If you have questions, contact the manufacturer.
 - b) Before servicing or cleaning unit, switch power off at service panel and lock the service disconnecting means to prevent power from being switched on accidentally. When the service disconnecting means cannot be locked, securely fasten a prominent warning device, such as a tag, to the service panel.
- Read and understand all instructions. Failure to follow all instructions may result in serious injury or property damage.
 - The warnings, cautions, and instructions in this manual cannot cover all possible conditions or situations that could occur. Exercise common sense and caution when using this fan. Always be aware of the environment and ensure that the fan is used in a safe and responsible manner.
 - Do not allow persons to operate or assemble the fan until they have read this manual and have developed a thorough understanding of how it works.
 - Do not modify this fan in any way. Unauthorized modification may impair the function and/or safety and could affect the life of the product. There are specific applications for which the product was designed.
 - Use the right fan for the job. DO NOT attempt to force small equipment to do the work of larger industrial equipment. There are certain applications for which this equipment was designed. It will do the job better and more safely at the capacity for which it was intended. DO NOT use this equipment for a purpose for which it was not intended.
 - Industrial or commercial applications must follow OSHA requirements.

WARNING

This product may contain chemicals known to the State of California to cause cancer, birth defects or other reproductive harm.

⚠WARNING

WORK AREA SAFETY

- Inspect the work area before each use. Keep work area clean, dry, free of clutter, and well-lit. Cluttered, wet, or dark work areas can result in injury. Using the fan in confined work areas may put you dangerously close to cutting tools and rotating parts.
- Do not use the fan where there is a risk of causing a fire or an explosion; e.g., in the presence of flammable liquids, gases, or dust. The product can create sparks, which may ignite the flammable liquids, gases, or dust.
- Keep children and bystanders away from the work area while operating the fan. Do not allow children to handle the tool.

⚠WARNING

PERSONAL SAFETY

- Unplug or disconnect the appliance from the power supply before servicing.
- Stay alert, watch what you are doing, and use common sense when operating the fan. Do not use the fan while you are tired or under the influence of drugs, alcohol, or medication. A moment of inattention while operating the tool may result in serious personal injury.
- Dress properly. Do not wear loose clothing, dangling objects, or jewelry. Keep your hair, clothing and gloves away from moving parts. Loose clothes, jewelry, or long hair can be caught in moving parts. Air vents on the tool often cover moving parts and should be avoided.
- Wear the proper personal protective equipment when necessary. Use ANSI Z87.1 compliant safety goggles (not safety glasses) with side shields, or when needed, a face shield. Use a dust mask in dusty work conditions. Also use non-skid safety shoes, hardhat, gloves, dust collection systems, and hearing protection when appropriate. This applies to all persons in the work area.
- Do not overreach. Keep proper footing and balance at all times.
- Do not use the tool when tired or under the influence of drugs, alcohol or medication.
- Ensure the power switch is off prior to plugging in the tool.

⚠WARNING

ELECTRICAL SAFETY

Avoid body contact with grounded surfaces such as pipes, radiators, ranges, and refrigerators. There is an increased risk of electric shock if your body is grounded.

⚠CAUTION

FAN USE AND CARE

- Check for damaged parts before each use. Carefully check that the fan will operate properly and perform its intended function. Replace damaged or worn parts immediately. Never operate the fan with a damaged part.
- Do not use a fan with a malfunctioning switch. Any fan that cannot be controlled with the power switch is dangerous and must be repaired by an authorized service representative before using.

- Disconnect the power from the fan and place the switch in the locked or off position before making any adjustments, changing accessories, or storing the fan. Such preventive safety measures reduce the risk of starting the fan accidentally.
- Surges in electrical power or excessive heat may cause the fan to turn off. Wait approximately 15 minutes for the fan to resume operation.
- Store the fan when it is not in use. Store it in a dry, secure place out of the reach of children. Inspect the fan for good working condition prior to storage and before re-use.
- Keep guards in place and in working order. Never operate the fan without the guards in place.
- Do not leave the fan running unattended.
- CAUTION : For general ventilating use only. Do not use to exhaust hazardous or explosive materials and vapors.

Specific Operation Warnings

⚠ WARNING

- Electric shock hazard. Do not expose fan to water or rain.
- To reduce risk of fire or electrical shock, do not use this fan with any solid state speed control.
- Be sure equipment is properly grounded.
- Do not use an extension cord with this product.
- Rotating blade hazard. Keep hands clear from blade during operation.
- DO NOT operate without guards in place.
- Automatically operated device. To reduce risk of injury, disconnect from the power supply before servicing.
- Explosion hazard. Do not use this fan in the presence of flammable liquids, gases or dust.
- Disconnect power before servicing.
- Installation work and electrical wiring must be done by qualified person(s) in accordance with all applicable codes and standards, including fire-rated construction.
- Use OSHA approved lock-out tag-out devices on power supply to prevent shock and/or electrocution.
- Sufficient air is needed for proper combustion and exhausting of gases through the flue (chimney) of fuel burning equipment to prevent back drafting. Follow the heating equipment manufacturer's guideline and safety standards such as those published by the National Fire Protection Association (NFPA), and the American Society for Heating, Refrigeration and Air Conditioning Engineers (ASHRAE), and the local code authorities.
- The fan frame and motor must be electrically grounded to a suitable electrical ground, such as a grounded water pipe or ground wire system.
- Install in interior wall. Not for use in kitchens.
- Be sure fan is mounted at least 8.2 feet (2.5m) above floor.
- Not for use by or around children.

Installation

⚠WARNING

TO REDUCE THE RISK OF FIRE, ELECTRIC SHOCK, OR INJURY TO PERSONS, OBSERVE THE FOLLOWING:

- a) Installation work and electrical wiring must be done by qualified person(s) in accordance with all applicable codes and standards, including fire-rated construction.
- b) When cutting or drilling into wall or ceiling, do not damage electrical wiring and other hidden utilities.
 - Installation must be performed in accordance with the requirement of NEC and CEC by authorized personnel only.
 - To reduce risk of fire or electrical shock, do not use this fan with any solid state speed control.
 - Be sure equipment is properly grounded.
 - Do not use an extension cord with this product.
 - Explosion hazard. Do not use this fan in the presence of flammable liquids, gases or dust.
 - Installation work and electrical wiring must be done by qualified person(s) in accordance with all applicable codes and standards, including fire-rated construction.
 - Sufficient air is needed for proper combustion and exhausting of gases through the flue (chimney) of fuel burning equipment to prevent back drafting. Follow the heating equipment manufacturer's guideline and safety standards such as those published by the National Fire Protection Association (NFPA), and the American Society for Heating, Refrigeration and Air Conditioning Engineers (ASHRAE), and the local code authorities.
 - The fan frame and motor must be electrically grounded to a suitable electrical ground, such as a grounded water pipe or ground wire system.
 - Install in interior wall. Not for use in kitchens.
 - Be sure fan is mounted at least 8.2 feet (2.5 meters) above floor.

The unit has to be securely mounted in a rigid framework. See the following chart for the recommended wall hole sizes.

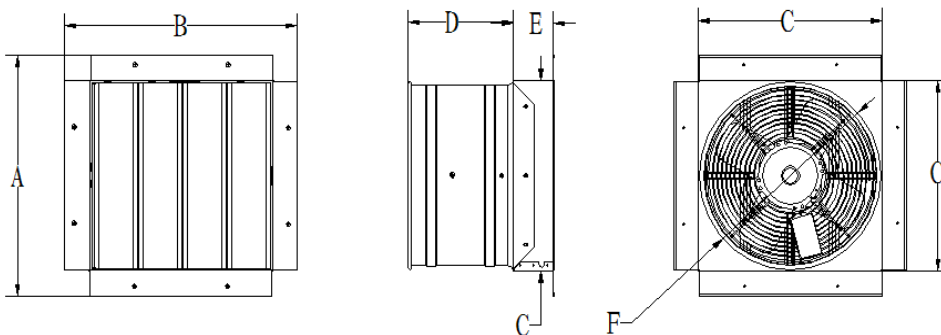

Model #	Size	A	B	C	D	E	F
52852	14"	20.6"	20.6"	16.9" square hole	9.4"	3.7"	16.2"
52853	18"	24.1"	24.1"	20.4" square	10.2"	3.7"	20"

				hole			
52854	30"	37.6"	37.6"	33.9" square hole	12.1"	3.7"	32.3"

1. Use screws, nuts, and flat referrals to assemble the fan head to the shutter assembly and then firmly fasten the nuts and flat referrals to lock into place.

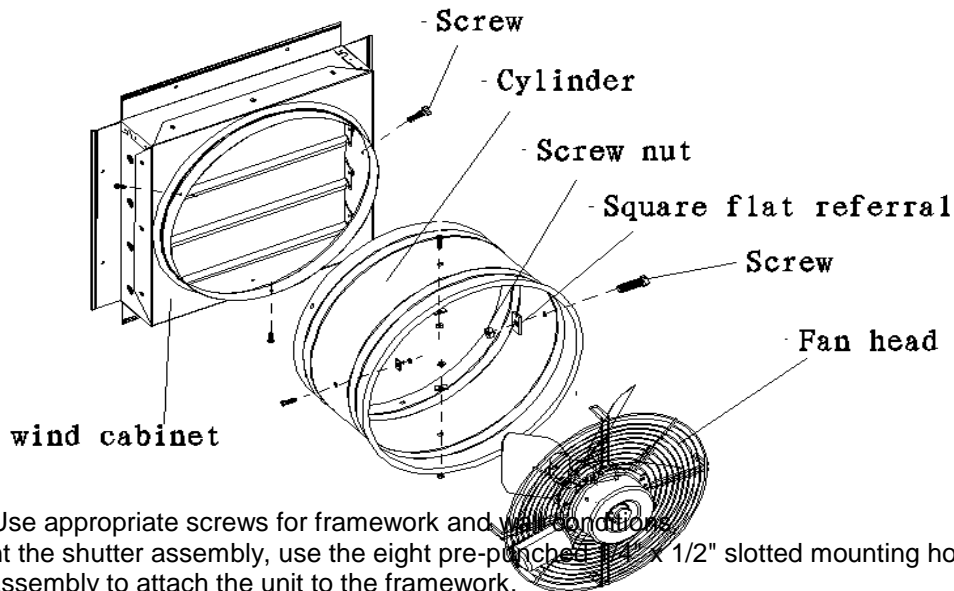

Important: Use appropriate screws for framework and wall conditions.

2. To mount the shutter assembly, use the eight pre-punched 3/4" x 1/2" slotted mounting holes of the shutter assembly to attach the unit to the framework.
3. Attach the fan to the installation wall surface as follows for applicable wall structure.

Wood Structure - Use 1/4" lag screws of appropriate length through each mounting hole.

Steel Structure - Use 1/4" bolt of appropriate length for application, in combination with a 1/4" flat washer and a 1/4" nut.

Masonry Structure - Use 1/4" lag screws in combination with a lag shield or equivalent 1/4" masonry fastener of appropriate length.

Note: The above mentioned hardware for mounting fans to wall surfaces is not provided by the manufacturer since each mounting application is different. However these items can be obtained from your local hardware store.

4. This unit is not equipped with a speed control switch, only a single exhaust air volume. Use the appropriate connection mode to connect the power supply. All connections in the junction box are connected to the power supply (see wiring diagram).

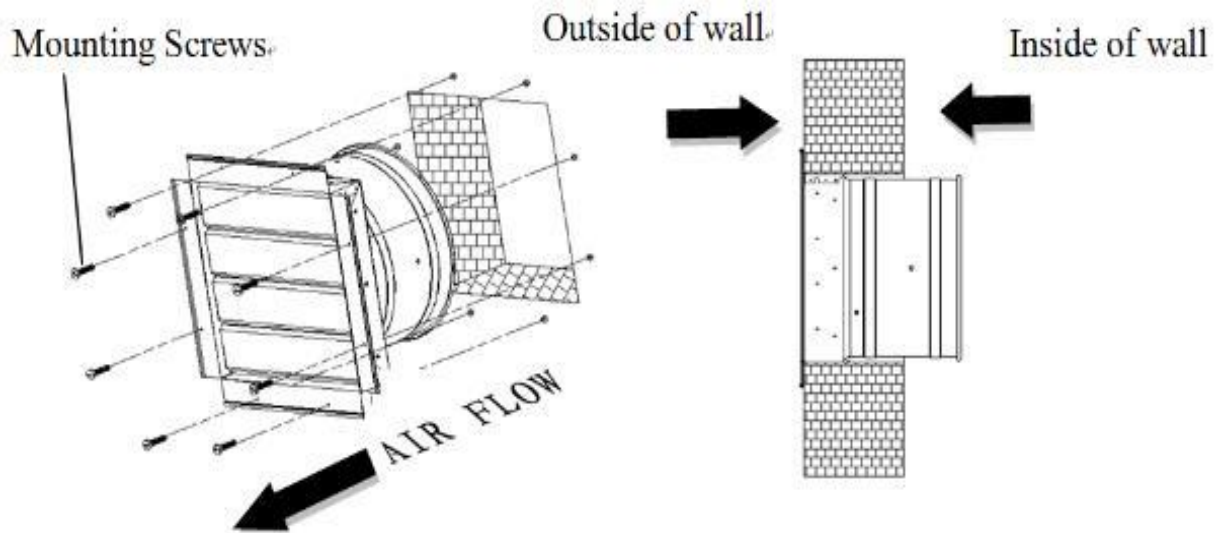

Note: Be sure when the fan is mounted that the shutter louvers open upward and close downward.

#52852, #52853, #52854 Wiring Diagram

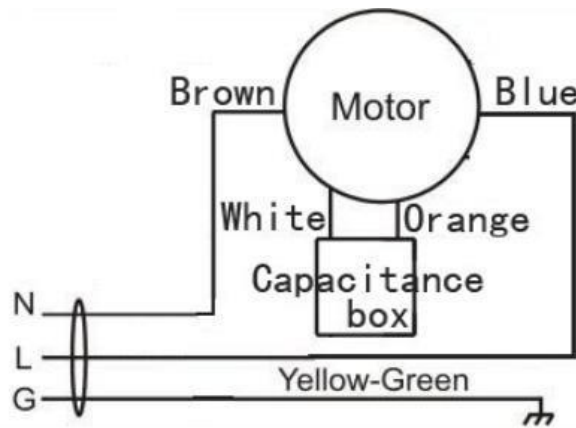

Before Each Use

⚠WARNING
 Be sure that both front and rear guard screws are completely tightened in locking position before operation.

Operating Instructions

This unit is not equipped with a speed selector. An external method of control will need to be wired. Refer to that specific control unit's installation instructions.

Maintenance

1. Disconnect the fan from the power supply before maintenance.

2. Use a soft damp cloth and wipe with a dry cloth.
3. The motor bearings are lubricated at the factory and should not require any additional lubrication. However, if bearing lubrication is needed, apply a small amount of a high temperature bearing grease.
4. Use a mild detergent to clean the blades and guards. Avoid allowing the cleanser to come in contact with the motor bearings or windings.
5. Allow the fan to completely dry before the next use.

⚠WARNING

- Disconnect power before servicing.
- Use OSHA approved lock-out tag-out devices on power supply to prevent shock and/or electrocution.

#52852 & #52853 Parts Diagram

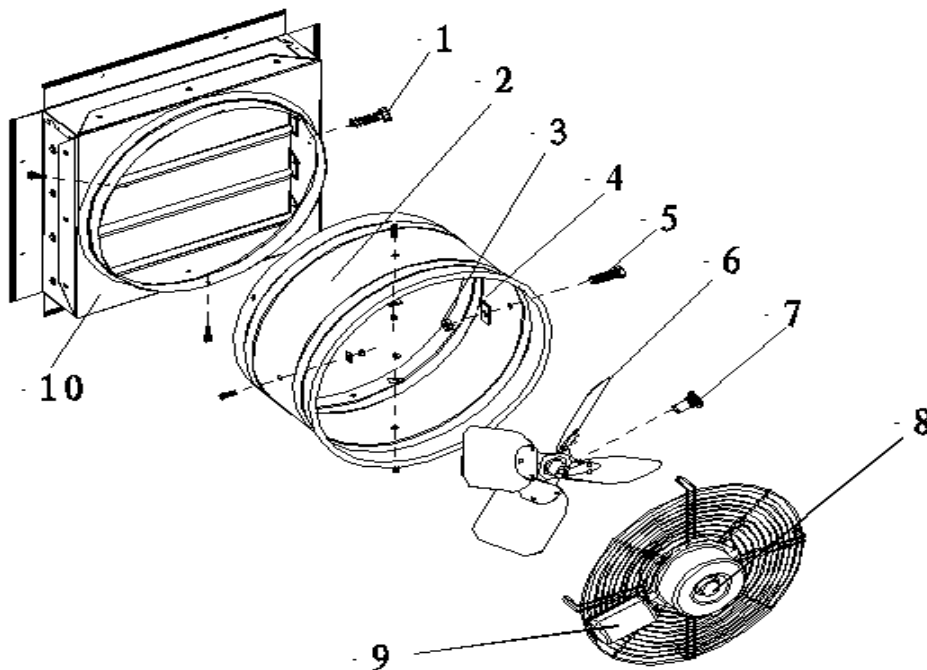

#52852

& #52853 Parts List

Part#	Description	Qty.	Part#	Description	Qty.
1	Screw	3	2	Cylinder	1
3	Screw nut	4	4	Square flat referral	4
5	Screw	4	6	Fan assembly	1

7	Screw	1	8	Motor	1
9	Capacitor box	1	10	Wind cabinet	1

#52854 Parts Diagram

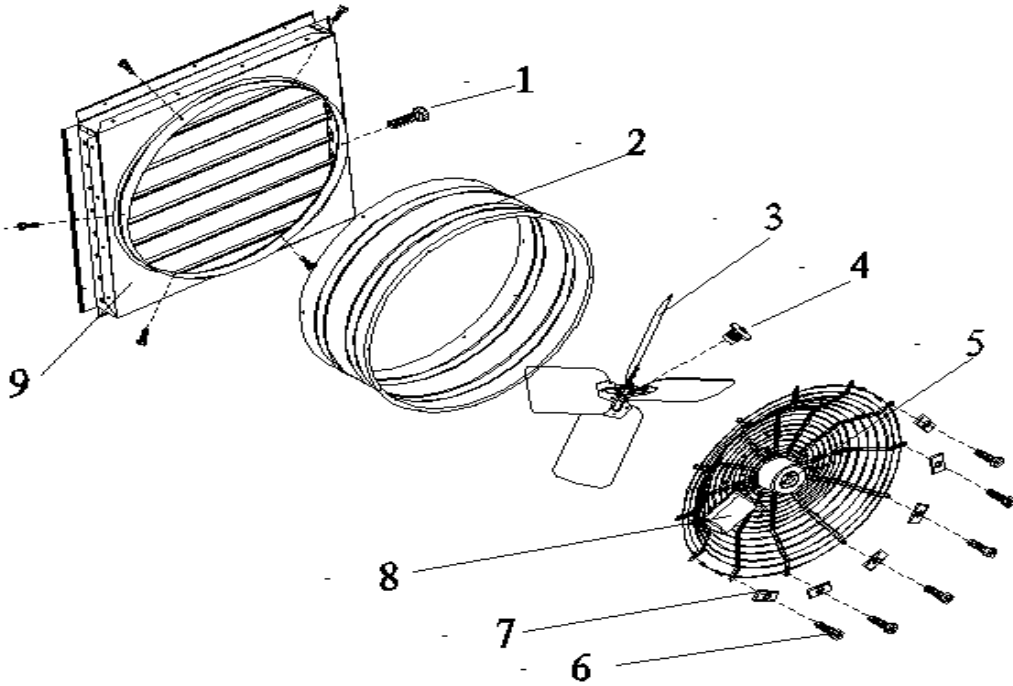

#52854 Parts List

Part#	Description	Qty.	Part#	Description	Qty.
1	Screw	6	2	Cylinder	1
3	Fan assembly	1	4	Screw	1
5	Motor	1	6	Screw	12
7	Fan assembly	12	8	Capacitor box	1
9	Wind cabinet	1			

Replacement Parts

- For replacement parts and technical questions, please call Customer Service at **1-800-222-5381**.
- Not all product components are available for replacement. The illustrations provided are a convenient reference to the location and position of parts in the assembly sequence.
- When ordering parts, the following will be required: Model Number, Serial Number/Lot Date Code, Description, and Reference Number.
- The distributor reserves the rights to make design changes and improvements to product lines and manuals without notice.

Limited Warranty

Northern Tool and Equipment Company, Inc. ("We" or "Us") warrants to the original purchaser only ("You" or "Your") that the Strongway product purchased will be free from material defects in both materials and workmanship, normal wear and tear excepted, for a period of **one year** from date of purchase. The foregoing warranty is valid only if the installation and use of the product is strictly in accordance with product instructions. There are no other warranties, express or implied, including the warranty of merchantability or fitness for a particular purpose. If the product does not comply with this limited warranty, Your sole and exclusive remedy is that We will, at our sole option and within a commercially reasonable time, either replace the product or product component without charge to You or refund the purchase price (less shipping). This limited warranty is not transferable.

Limitations on the Warranty

This limited warranty does not cover: (a) normal wear and tear; (b) damage through abuse, neglect, misuse, or as a result of any accident or in any other manner; (c) damage from misapplication, overloading, or improper installation; (d) improper maintenance and repair; and (e) product alteration in any manner by anyone other than Us, with the sole exception of alterations made pursuant to product instructions and in a workmanlike manner.

Obligations of Purchaser

You must retain Your product purchase receipt to verify date of purchase and that You are the original purchaser. To make a warranty claim, contact Us at 1-800-222-5381, identify the product by make and model number, and follow the claim instructions that will be provided. The product and the purchase receipt must be provided to Us in order to process Your warranty claim. Any returned product that is replaced or refunded by Us becomes our property. You will be responsible for return shipping costs or costs related to Your return visit to a retail store.

Remedy Limits

Product replacement or a refund of the purchase price is Your sole remedy under this limited warranty or any other warranty related to the product. We shall not be liable for: service or labor charges or damage to Your property incurred in removing or replacing the product; any damages, including, without limitation, damages to tangible personal property or personal injury, related to Your improper use, installation, or maintenance of the product or product component; or any indirect, incidental or consequential damages of any kind for any reason.

Assumption of Risk

You acknowledge and agree that any use of the product for any purpose other than the specified use(s) stated in the product instructions is at Your own risk.

Governing Law

This limited warranty gives You specific legal rights, and You also may have other rights which vary from state to state. Some states do not allow limitations or exclusions on implied warranties or incidental or consequential damages, so the above limitations may not apply to You. This limited warranty is governed by the laws of the State of Minnesota, without regard to rules pertaining to conflicts of law. The state courts located in Dakota County, Minnesota shall have exclusive jurisdiction for any disputes relating to this warranty.



Distributed by:

Northern Tool & Equipment Company, Inc.

Burnsville, Minnesota 55306

www.northerntool.com

Made in China