





# KM 129

## Uni Pro™ Bucket Seat



### CHOOSE FROM

-  OR  OR  OR  OR 
- Black Vinyl PN: 7104 | Gray Vinyl PN: 7102 | Camo Vinyl w/Hinge Bracket PN: 6802 | Yellow Vinyl PN: 7103 | Yellow Vinyl w/Hinge Bracket PN: 6801



Vacuum formed waterproof vinyl cover adds comfort and durability

Durable blow molded plastic frame is corrosion resistant

Drain hole prevents water build-up

See **REVERSE** for applications and options.

- **Milsco XB200 Seat**
- Uses standard 5/16 18UNC bolts
- Multiple mounting patterns
- Mounting patterns include (W x D): 8" x 11.5" or 11.25" x 11.5"



[TRACTORSSEATS.com](http://TRACTORSSEATS.com) [CONSTRUCTIONSEATS.com](http://CONSTRUCTIONSEATS.com) [TURFSEATS.com](http://TURFSEATS.com)

**800-328-1752**

308 NW 2nd Street • Renville, MN 56284



## APPLICATIONS



Lawn Mowers



Light Construction

### Fits - John Deere® Skid Steers

The below applications require you to order PNs: 6801 or 6802 which include the JD Turf Utility Seat Bracket (PN: 6003) that allows the seat to hinge forward.

240, 245, 260, 265, 285, 320, 325 (Serial No. 70001 & Up), 335 (Serial No. 70001 & Up), 345 (Serial No. 70001 & Up), 415 (Serial No. 70001 & Up), 425 (Serial No. 70001 & Up), 445, 455, F710 (Serial No. 090001 & Up), F725 (Serial No. 090001 & Up), F735, G100, SST16, SST18;  
**LX Series** LX172, LX173, LX176, LX178, LX186, LX188

## OPTIONS

- 7946 Armrest Kit
- 7911\* Lap Belt
- 7925\* 45.5" Retractable Seat Belt
- \*6002 Seat Belt Bracket  
(Necessary with PNs: 7911 & 7925)
- 8443 47" Retractable Seat Belt with Switch
- 8590 51.5" Orange Retractable Seat Belt
- 6043 Slide Rail Kit
- 8666 Operator Presence Switch  
(Normally Open)
- 8667 Operator Presence Switch  
(Normally Closed)
- 8671 4-Prong Operator Presence Switch  
(Normally Closed)

### FRONT VIEW

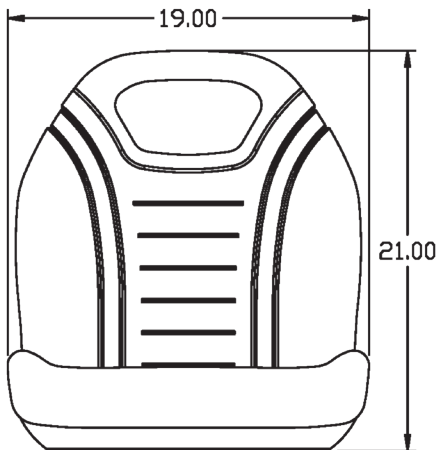

### SIDE VIEW

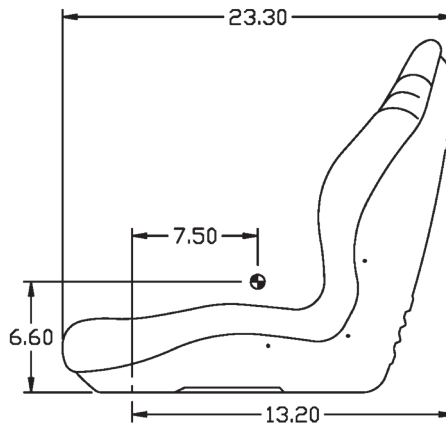

### JD TURF UTILITY SEAT BRACKET

Included with PNs: 6801 and 6802

